

CD 41

Baby Doll



24 modeller til babyer eller dukker.

Kjoler, trøjer, bluser, sparkedragter, køre-
poser, bodystocking, kyser

Beskrivelser af arbejdsgang på dansk.

v. II - personal patterns med flere faciliteter

Personal Pattern — Perfekt Pasform

Et skridt foran i modesyning

For flere informationer og nyheder klik ind på

www.pppp.dk

v. II med flere faciliteter:

*Udskrivning af alle mønsterdelene på en gang
Tilrettelæggelse af mønsterdelene på stof
Beregning af stofforbrug*

CD SNITMØNSTRE — SÅ NEMT ER DET:

- Sæt cd'en i computeren — programmet starter op af sig selv
- Indtast personlige mål:
 - I højde
 - II brystvidde
 - III taljevidde
 - IV hoftevidde
- Vælg model
- Print snitmønstret ud fra din egen printer
- Sæt arkene sammen
- Klip og sy

God fornøjelse

Olga Christensen

7124

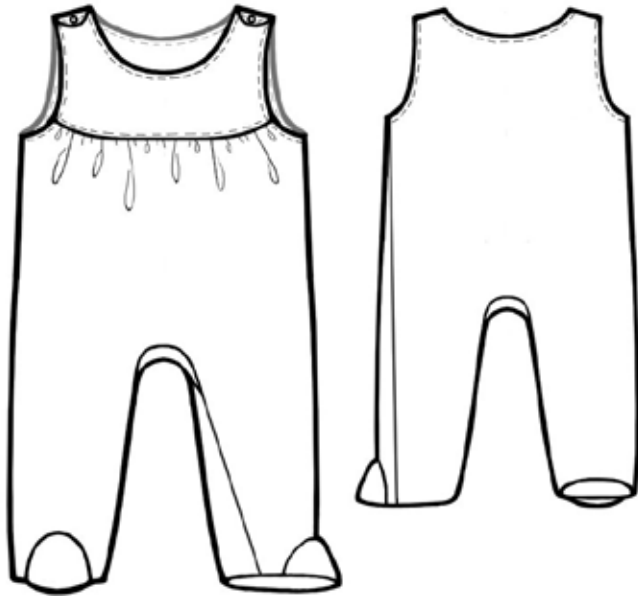

7125

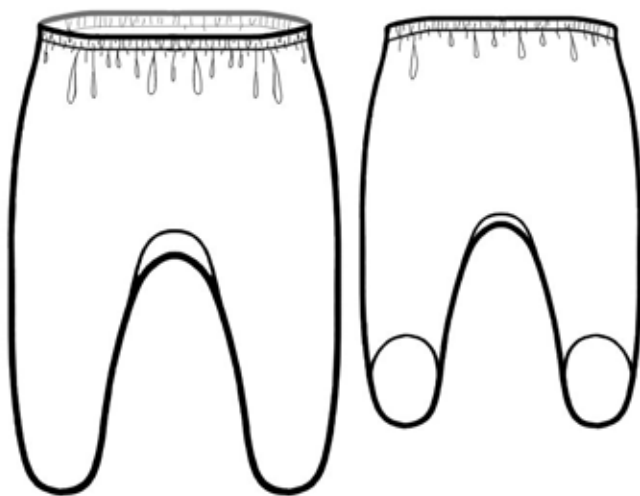

7126



7127

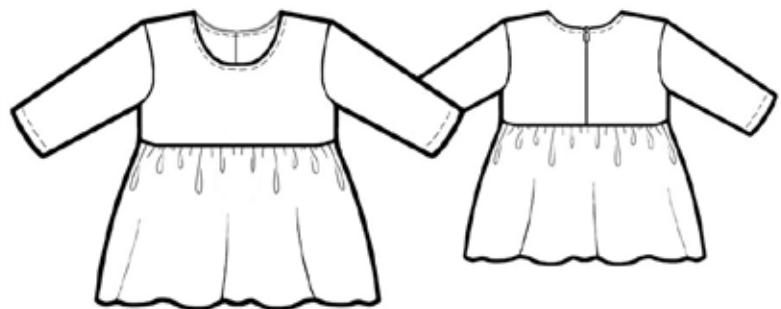

7128

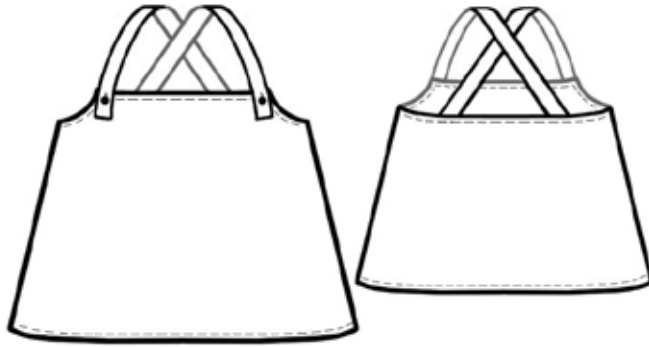

7129

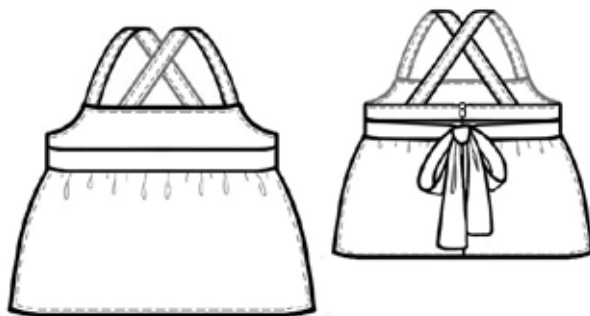

7130



7131

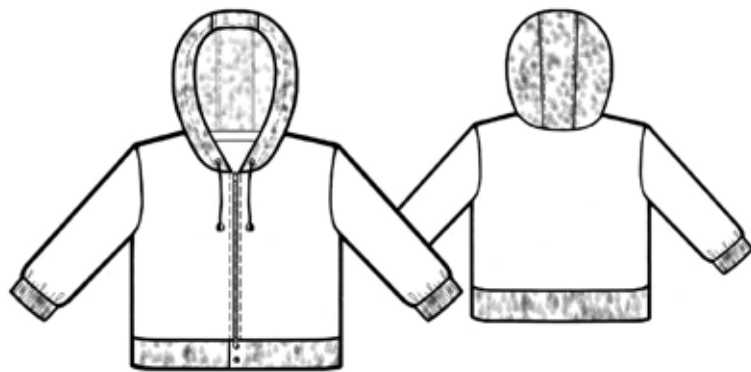

7132

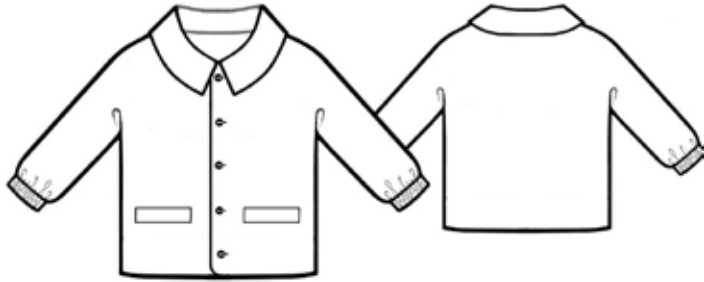

7133



7134

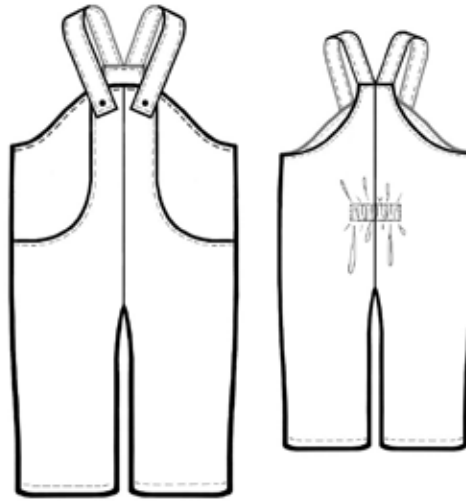

7135



7136

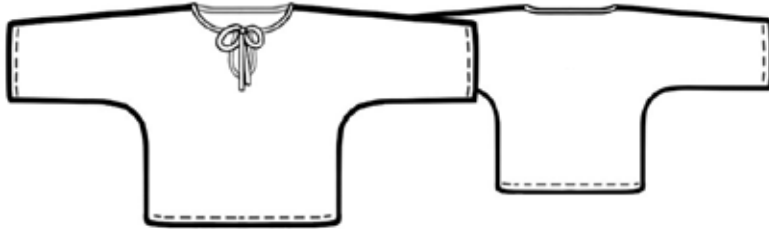

7137

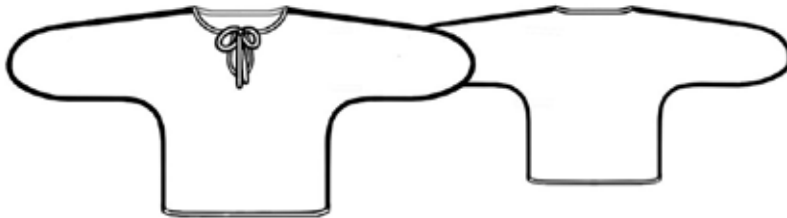

7138

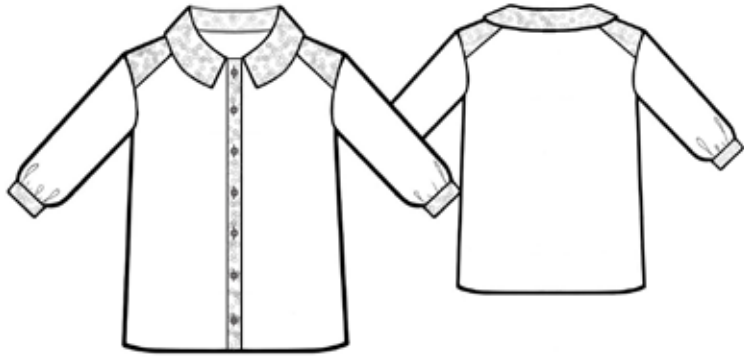

7139



7140

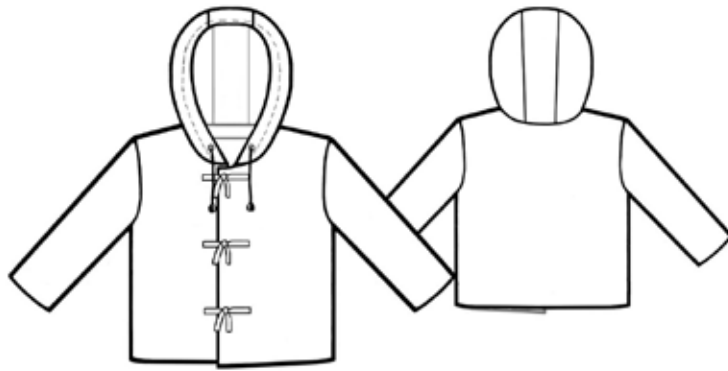

7141

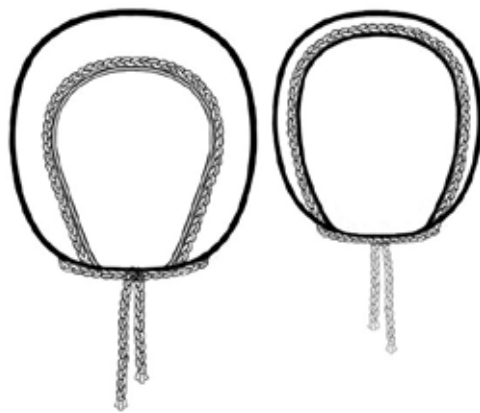

7142

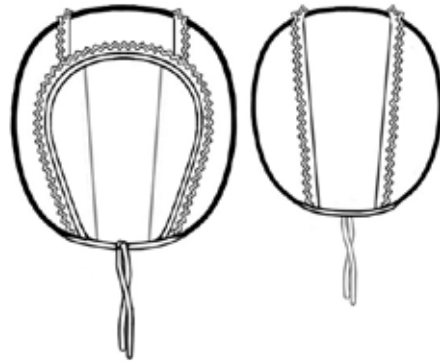

7143

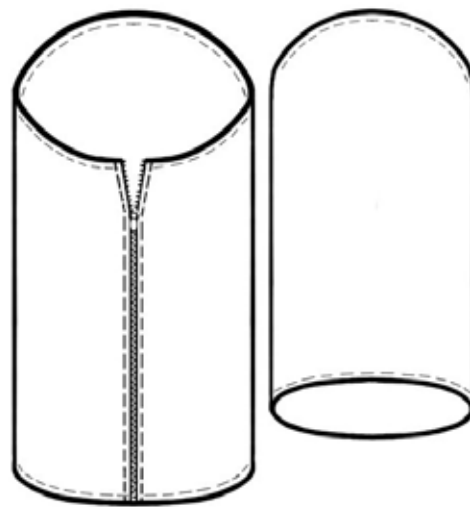

7144

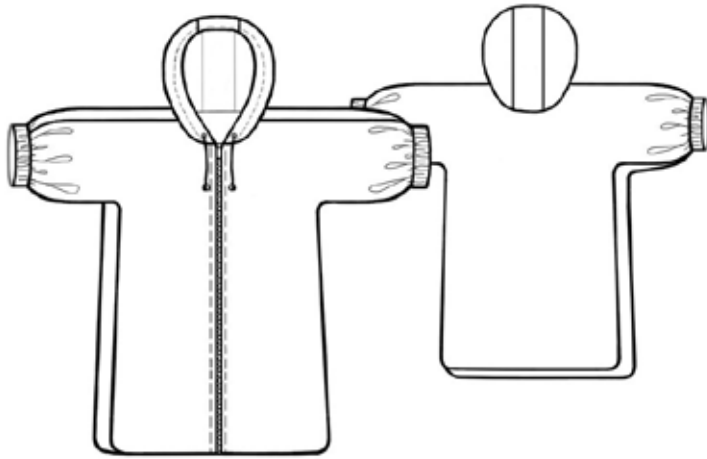

7145

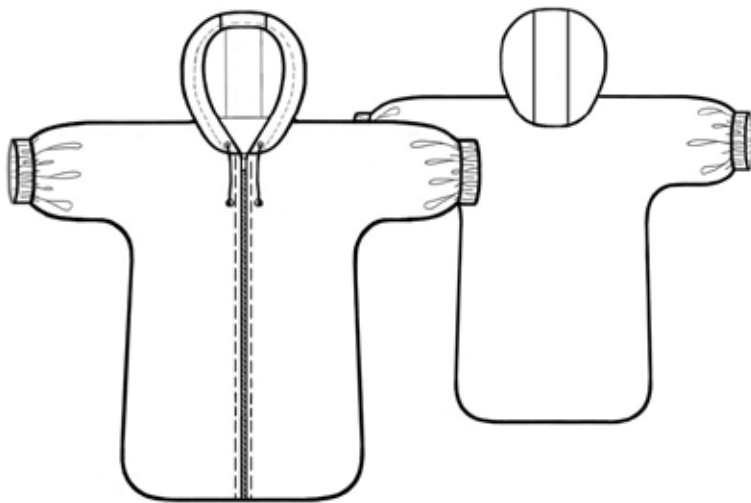

7146

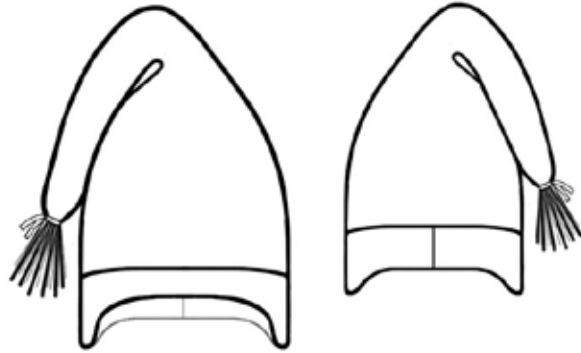

7147

